

E015SPR840DACCB | KEPLERO 160 Adjustable

Compact inground adjustable projector equipped with LED sources

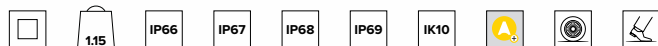

	4000K	H(m)	D(m)	Emax(lx)		
	Ra80		11°			
Fixture Power	14W	1	0.20	19445		
Source Flux	1946lm	2	0.39	4861		
Fixture Flux	1521lm	3	0.59	2161		
Efficacy	111lm/W	4	0.79	1215		
TS821	Imax=9992cd/klm	Imax	19445cd	5	0.99	778

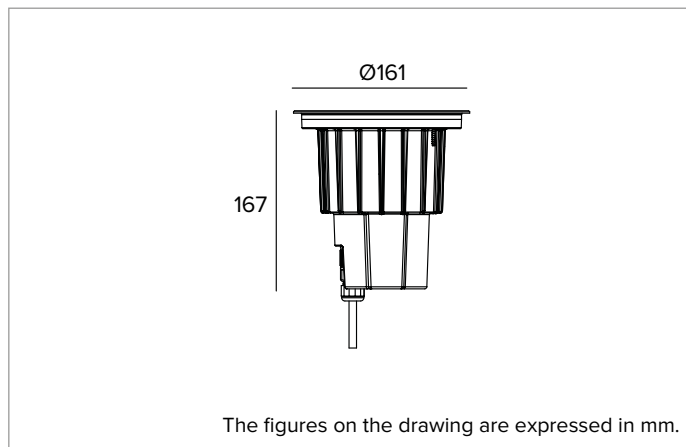

SOURCE

High efficiency Chip on Board LED Ra80. 3500K colour temperature available on request.

Energy efficiency class: D

Nominal power: 12W

Nominal flux: 1946lm

Colour rendering index: 80

Rf: 82

Rg: 95

CCT nominal: 4000K

Lifetime (L80/B10): >50000h tq +25°C

ILLUMINOTECHNICAL CHARACTERISTICS

Reflector optical system with a high efficiency reflector available with three different beam openings. Aiming using a tilting system up to 20° on the vertical axis and 360° on the horizontal plane with a friction aim locking system.

Optic: REFLECTOR

Beam angles: SP

Optical efficiency: 78%

Fixture flux: 1521lm

Luminous efficacy: 111lm/W

Photobiological safety: Compliant with RG1 low risk group

MECHANICAL CHARACTERISTICS

Die-cast aluminium body with 3 layers of protection: anodised, cataphoresis and black paint. Brushed stainless steel (AISI 316) ultra flat decorative ring with bevelled edge (copper bronze finish). Version with extra-clear protective glass. Anti theft stainless steel A4 Torx screws.

Colour and finish: Copper bronze

Weight: 1.15Kg

Version: STANDARD

Degree of protection: IP66,IP67,IP68,IP69

Mechanical Resistance: IK10

ELECTRICAL CHARACTERISTICS

110-240Vac power supply with an integrated DALI driver. Connection to the mains via IP68 watertight connectors for H07RN8-F cable (max 2x2.5mm²).

Fixture Power: 14W

Power supply: 110-240V 50/60Hz

Insulation Class: CLASS 2

Type of driver / Control: DALI

Driver included: YES

Class F: YES

SAFE FLICKER: PstLM=<1 and SVM=<0.4 (IEC TR 61547-1 and IEC TR 63158), to ensure a more comfortable and safe light

Ambient temperature: -25°C / +35°C

INSTALLATION

Nylon installation sleeve to be ordered separately as an accessory. The sleeve is pre-set for both flush or straight edge installation. 20kN resistance to static load.

NOTES

All light fixtures must be completed with an installation sleeve. IP68: the fixture is not suitable for permanent underwater installation but can withstand temporary accidental immersion to a depth of 2 metres (max.24h). IP69: IEC/EN 60529 standard compliant. All versions of the KEPLERO family meet all the requirements of EN 60598-2-13 standard regarding drive-over and walk-over performances. Low temperatures on the glass make them suitable even for installation in "special areas", such as spaces for children. Uses the "Waterblock Smart" technical solution that involves resin coating the connection cables, limiting the risk of humidity reaching the driver or the fixture. 110-277Vac version available on request. Commissioning of the control system via free APP; the intervention of a specialist technician can be quoted on request.

WARNING

Luminaire designed for disposal/recycling at end-of-life. Replaceable (LED only) light source by a professional. Replaceable control gear by a professional.

Due to the technological evolution of the electronic components, the data provided may be updated, and as such, confirmation must be requested during the order process.

Luminous flux and power supply have +/-10% tolerances with respect to the indicated value. tq +25°C (CIE 121).

We reserve the right to make technical changes.

Targetti Sankey S.r.l.
Via Pratese, 164
50145 Firenze - Italy
Tel: +39 055 37911
targetti.com
targetti@targetti.com

CCIAA Firenze
Share Capital:
€ 500.000,00
VAT N. (IT):
01537660480
R.E.A: FI-275656

TARGETTI

E015SPR840DACCB | KEPLERO 160 Adjustable

Compact inground adjustable projector equipped with LED sources

Related codes

Sleeve



Ø mm	H mm	Code
166	200	1E2521

Installation sleeve.
Grey Nylon casing.
For flush and semi-flush installation.

Accessories

Filter



Ø mm	Code
70	1T1708

Flat striped glass blade light refractive filter.
This makes the beam take on an oval shape and when combined with spotlights, the light blade appears more prominent.
To be completed with accessory holder ring A079 (reflector optics only).
Cannot be used with VNL optics.

Grid



Ø mm	Code
70	1T1711

Anti-glare louver.
Black painted metal honeycomb structure.
To be completed with accessory holder ring A079 (reflector optics only).
Cannot be used with VNL optics.

Screen



Colour	Code
●	A079

Black polycarbonate accessory holder ring.

Shutter



Colour	Code
●	1E2523

Black half-moon shutter.

Tool



Code
1E0388

Sucker tool to raise the glass.



Code
1E2495

Features TORX HEAD, TX 30.

Due to the technological evolution of the electronic components, the data provided may be updated, and as such, confirmation must be requested during the order process.
Luminous flux and power supply have +/-10% tolerances with respect to the indicated value. tq +25°C (CIE 121).

We reserve the right to make technical changes.

Targetti Sankey S.r.l.
Via Pratese, 164
50145 Firenze - Italy
Tel: +39 055 37911
targetti.com
targetti@targetti.com

CCIAA Firenze
Share Capital:
€ 500.000,00
VAT N. (IT):
01537660480
R.E.A.: FI-275656

TARGETTI

E015SPR840DACCB | KEPLERO 160 Adjustable

Compact inground adjustable projector equipped with LED sources

Tool



Code

1E2524

Metal handle for fixture removal

Connector



Code

1E2769

Linear connection box IP66/IP68.
5 poles max. wire section 1.5mm².
Cable diameter range from 7 to 12mm.

Control systems



Code

1E3048

IP67 wireless control unit with DALI interface.
It generates a local DALI2 bus, enabling a direct connection to a DALI interface LED driver.

The module can only be used in a closed system and cannot be connected to an existing DALI network.

The module is wireless controlled using a Casambi app for smartphones and tablets using Bluetooth 5.0 technology.

The devices automatically create an adaptive, robust, and reliable wireless mesh network, allowing for the easy and efficient management of a high number of fixtures. The control unit is preset to the DALI 1CH profile, meaning the device can control a single DALI driver with broadcast commands.

In addition to the DALI broadcast, other operating modes are available, such as:

- Button (normally open)
- Control unit 0/1-10V
- Control unit DALI Tunable White DT8
- Presence sensor



Code

1E4369

IP67 Extender for wireless control of LED driver with dimming DALI interface based on Casambi technology.

It has a DALI2 output with the capacity to control up to 40 lighting fixtures. With the addition of a further external BUS DALI power supply it is possible to control up to 64 fixtures.

IP67 Extender is preset to the DALI broadcast profile, meaning all the luminaires connected to it are dimmable at the same level.

In addition to the DALI broadcast other operating modes are available, such as:

- EXTENDER DALI 8CH
- EXTENDER DALI Tunable White
- EXTENDER DALI 4CH
- EXTENDER DALI DT8 Tunable White

Due to the technological evolution of the electronic components, the data provided may be updated, and as such, confirmation must be requested during the order process.

Luminous flux and power supply have +/-10% tolerances with respect to the indicated value. tq +25°C (CIE 121).

We reserve the right to make technical changes.

Targetti Sankey S.r.l.
Via Pratese, 164
50145 Firenze - Italy
Tel: +39 055 37911
targetti.com
targetti@targetti.com

CCIAA Firenze
Share Capital:
€ 500.000,00
VAT N. (IT):
01537660480
R.E.A.: FI-275656

TARGETTI

E015SPR840DACCB | KEPLERO 160 Adjustable

Compact inground adjustable projector equipped with LED sources

Surge protector



Code

A013D

Surge protector compatible with CLASS II lighting fixtures.

DALI, DMX, 0-10V datalines compliance.

Operating voltage 230-277Vac.

SPD type 2+3.

Max surge protection 10kV.

CLASS II

IP65

Due to the technological evolution of the electronic components, the data provided may be updated, and as such, confirmation must be requested during the order process.

Luminous flux and power supply have +/-10% tolerances with respect to the indicated value. tq +25°C (CIE 121).

We reserve the right to make technical changes.

Targetti Sankey S.r.l.
Via Pratese, 164
50145 Firenze - Italy
Tel: +39 055 37911
targetti.com
targetti@targetti.com

CCIAA Firenze
Share Capital:
€ 500.000,00
VAT N. (IT):
01537660480
R.E.A: FI-275656

TARGETTI